

5 Easy Steps

The fastest way to setup your CS70 Headset System

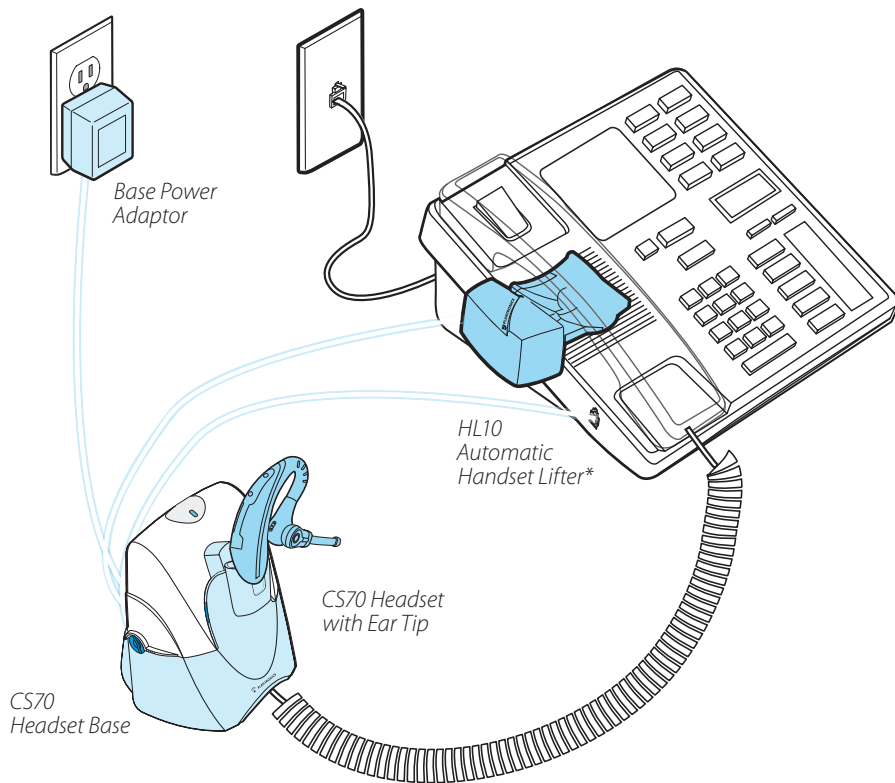

*Not included in all configurations



PLANTRONICS
SOUND INNOVATION™

CS70 PACKAGE CONTENTS

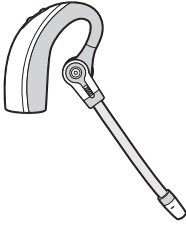

Headset

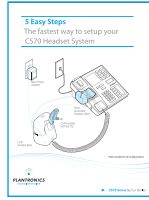

Setup Guide

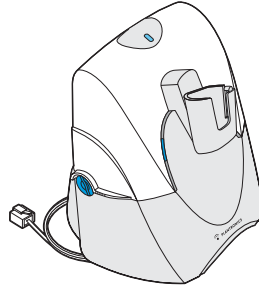

Headset Base with Pre-installed Phone Cable



Base Power Adapter



Ear Tips



Please refer to the separate Safety Instructions sheet for important product safety information prior to installation or use of the product.

CS70 With Handset Lifter* Adds:

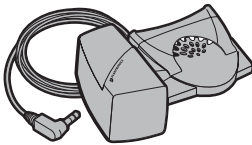

HL10 Automatic Handset Lifter



HL10 User Guide

*Automatic Handset Lifter is bundled with certain CS70 configurations and also available separately.

HL10 Additional Parts Kit (if needed)

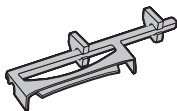

Extender Arm



Ringer Microphone



Adapter for Nortel i2004 Phones

INSTALL EAR TIP & ADJUST FIT

Fit the Headset

Slide the headset over and behind your ear, then press gently toward your ear. Rotate the microphone boom until it is pointed toward your mouth. If the ear tip is uncomfortable, install a different ear tip. See below.

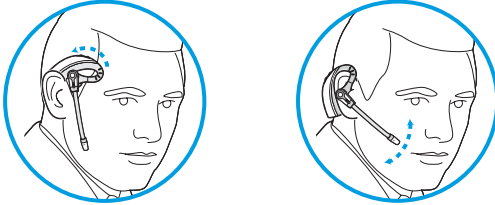

For your safety and comfort, the ear tip should never be inserted into the ear canal.



To Install a Different Ear Tip

Remove the pre-installed ear tip by pushing in and turning the ear tip **CLOCKWISE**, then pull firmly.

Choose the style and size of Ear Tip that fits most comfortably. Align Ear Tip tabs with notches in headset.

Push in firmly and twist **COUNTER** clockwise.

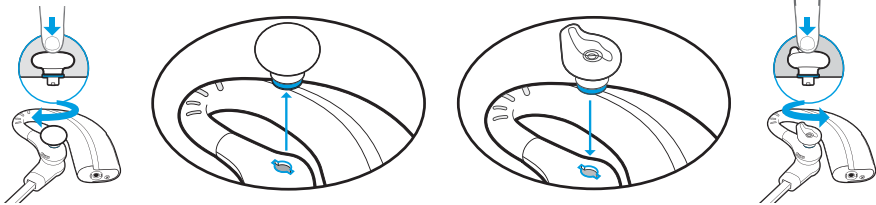

To view an interactive set-up guide online, visit www.plantronics.com/cs70setup and click on *Adjusting Fit*.



To Convert for Wearing on Left Ear

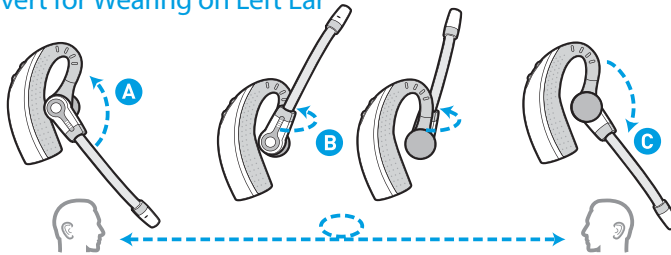

A. Rotate microphone boom up

B. Turn microphone boom around

C. Rotate microphone boom down

2 CONNECT BASE TO DESK PHONE

Use **Configuration A** if:

You will use the Automatic Handset Lifter

or...

Your phone has NO built-in headset functionality (no Headset button).

Configuration A

1. Unplug the handset coil cord from the desk phone handset port [A], then plug it into the **GREEN** labeled handset port [B] on the Headset Base.

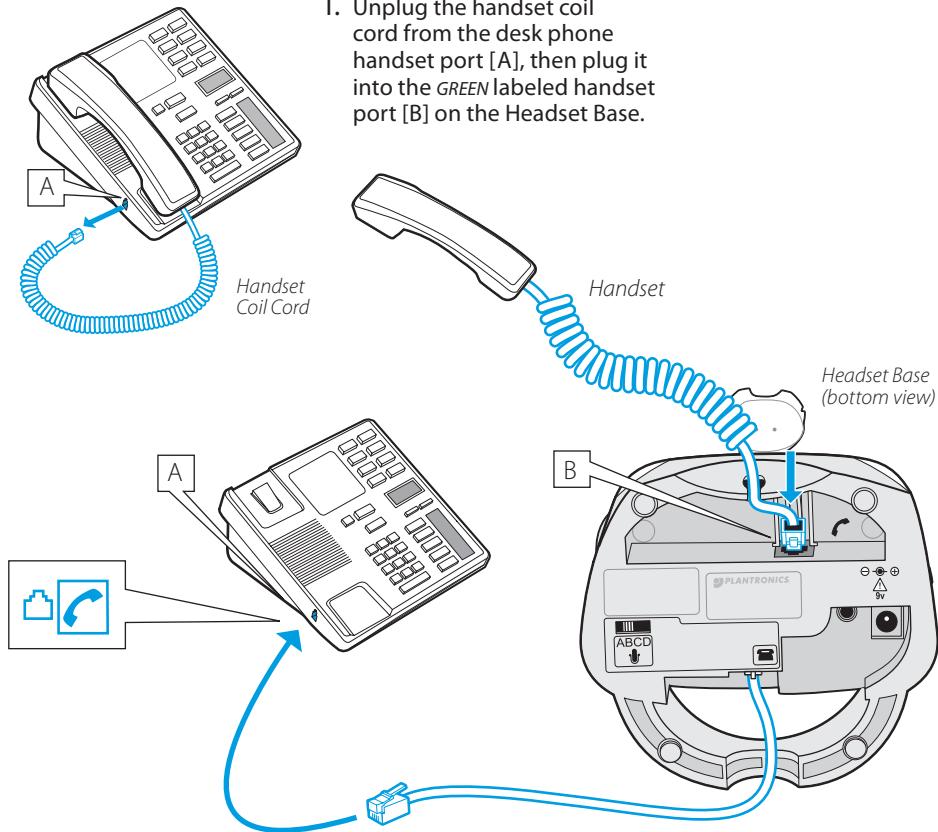

2. Plug the short **BLACK** Phone Cable that is pre-installed on the Headset Base into the now-open handset port [A] on the desk phone.

Use **Configuration B** if:

You will NOT use the Automatic Handset Lifter
and...

Your phone has built-in headset functionality (a Headset button).

Configuration B

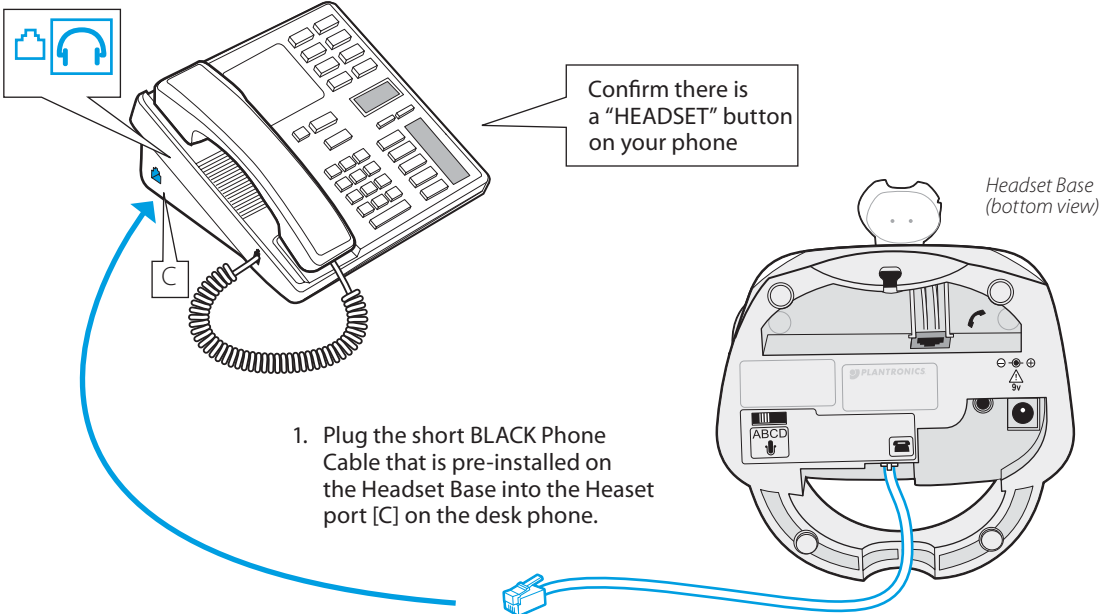

  or   ?

HANDSET port or HEADSET port?

You should only use the headset port if you will **NOT** be using the Automatic Handset Lifter **AND** you have a pre-programmed Headset button on your phone.

In this configuration you **MUST** press both the Headset button on your phone and the Call Control Button on the headset to answer/end calls.

3 CONNECT POWER AND CHARGE HEADSET

A. Connect Headset Base to power outlet

1. Plug the Base Power Adapter into a wall outlet, then plug the power cord into the *YELLOW* labeled connector on the bottom of the Headset Base. The *RED* Power light on the left front of the Headset Base will turn on. (See illustration at bottom of page.)

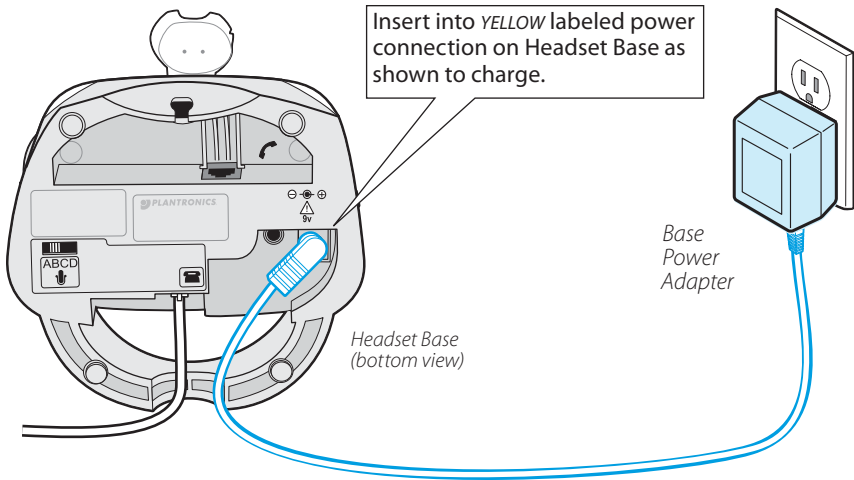

B. Charge the Headset for at least 20 Minutes before using

1. Gently push the headset into the charging cradle as shown below. The *AMBER* Charge Status light on the base will flash to indicate the headset battery is charging. A solid light indicates full charge. A full charge will take approximately 3 hours.

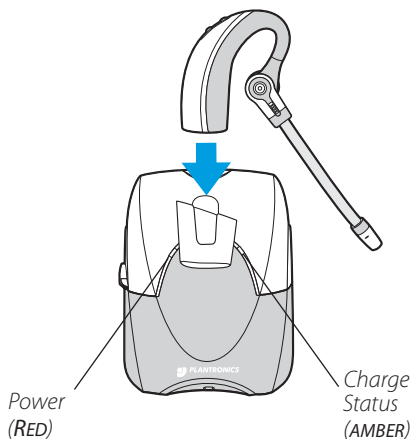

IMPORTANT! Make sure the headset is facing correctly (as shown at left) when inserted into the charging cradle.

INSTALL AUTOMATIC HANDSET LIFTER

If you do not have the Lifter, skip to step 5.

Why use a handset lifter? The lifter greatly simplifies using a headset with your desk phone. It lets you answer and end calls without being near your phone.



The HL10 Automatic Handset lifter is included with certain CS70 configurations and is also available separately.

A. Connect Handset Lifter power cord to Headset Base

1. Verify that the base-to-desk Phone Cable is connected to the handset port of the desk phone, and not the headset port (Refer to Step 2, Configuration A).
2. **FIRMLY PRESS** the Handset Lifter power cord into the **RED** labeled port to ensure a complete connection.

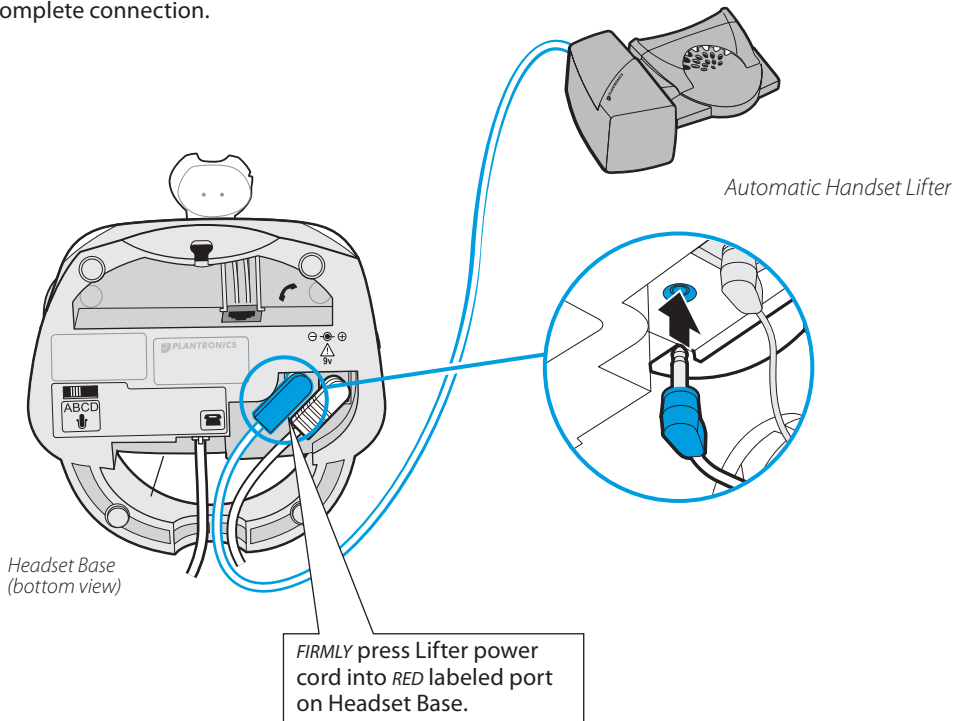

B. Determine Lifter position and height setting

1. Set the Lifter Height Switch to the lowest setting.

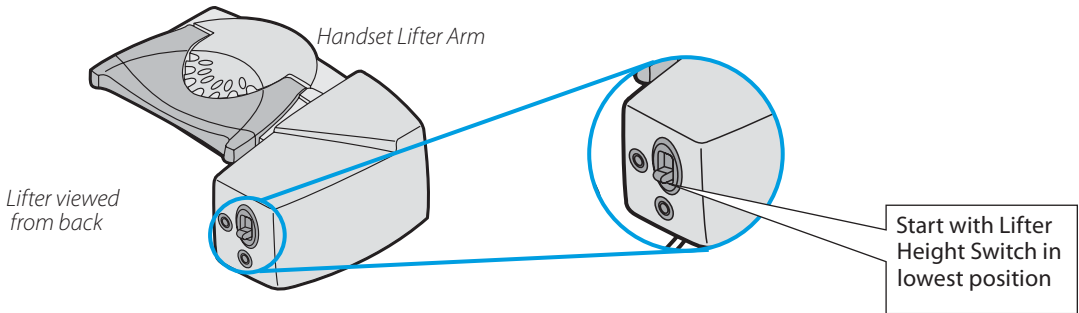

2. While wearing your headset, slide the Handset Lifter Arm under the handset until the lifter base touches the side of the phone.
3. Slide the Lifter to where it nearly touches the handset earpiece.

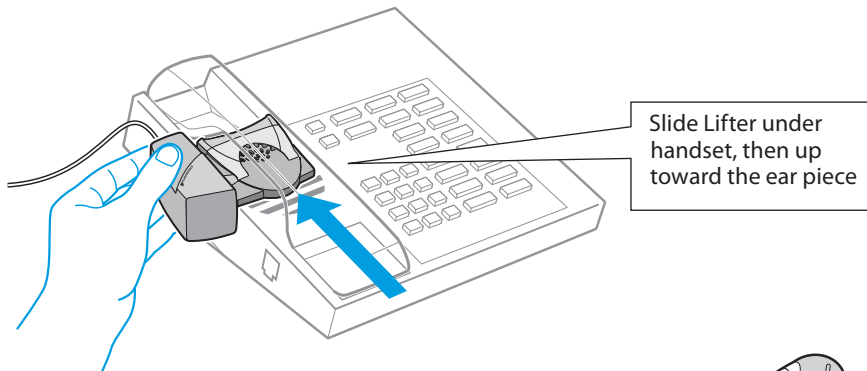

4. Press the Call Control Button on the headset. This will activate the Handset Lifter and lift the handset from the phone.

If you hear a dial tone, the lifter height is set correctly and needs no adjustment. Please continue with the next section "Mount the Lifter in Permanent Position".

5. If you do not hear a dial tone, the Lifter may not be raising the handset high enough OR the Configuration Dial may need adjusting. Continue to step 6.

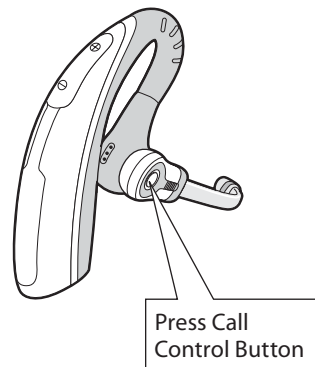

6. Check the Lifter height adjustment by moving the Lifter Height Switch to a higher position. Repeat steps 2. through 4. as necessary.

If you hear a dial tone, the lifter height is now set correctly. Please continue with the next section "Mount the Lifter in Permanent Position".

7. If you still cannot hear a dial tone, you will need to change the setting on the Configuration Dial. Using a coin or paperclip, turn the Configuration Dial to a different setting until you hear a dial tone. Multiple settings might work with your phone; however, only one is the optimal position. If you still cannot hear a dial tone, please call Technical Support at 800-544-4660 Extension 5538.

Configuration Dial

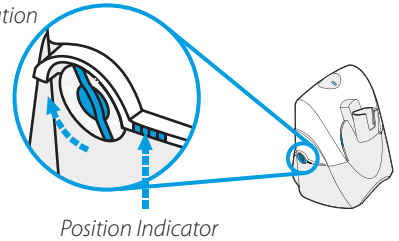

Position Indicator

To view an interactive set-up guide online, visit www.plantronics.com/cs70setup and click on Compatibility.



Use the Extender Arm to Stabilize Handset (if needed)

If your handset falls off the phone base or does not return to its cradle when lowered, you will need to attach the Extender Arm to the Lifter as described in the HL10 Additional Parts Kit.

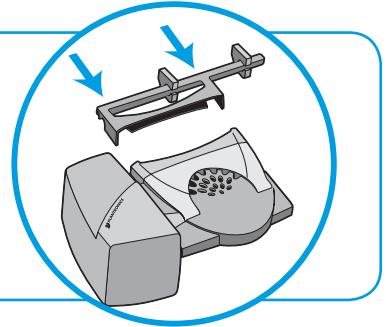

C. Mount the Lifter in permanent position

1. Remove the protective strips from the three mounting tapes on the underside of the Lifter.
2. *GENTLY* place the Lifter on the desk phone in the optimum position as determined above. Test the Lifter to verify positioning by pressing the Call Control Button on your headset to activate the Lifter and listen for a dial tone.
3. Press *FIRMLY* to adhere the Lifter to the desk phone.

Peel back mounting tape protective strips (3 places)

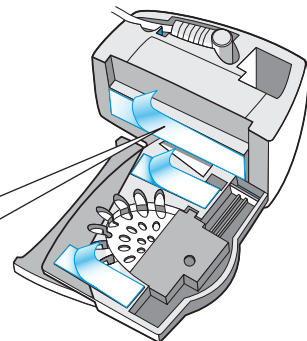

5 MAKE A TEST CALL TO CONFIGURE AND OPTIMIZE YOUR SYSTEM.

To get the best sound quality for both you and your listeners You MUST configure and optimize your system!

A. Make the test call

1. If your desk phone has a volume control, set it to mid-range.
2. If you have installed the Automatic Handset Lifter, press the Call Control Button on your headset.

If you have *NOT* installed the Automatic Handset Lifter, press the Call Control Button then lift the handset from its cradle (or press the HEADSET button on your telephone, if it has one).
3. Verify that you hear a dial tone. If so, continue with step 4.

IF YOU DO NOT HEAR A DIAL TONE: Use a coin or paperclip to turn the Configuration Dial to a different setting until you hear a dial tone.
If you still do not hear a dial tone at any of the four positions, review Setup Guide Steps 1–4 to verify completion.
4. Make the test call (TOLL FREE). It's the quickest way to test and optimize your system.

Automated Sound Test
866-210-2157

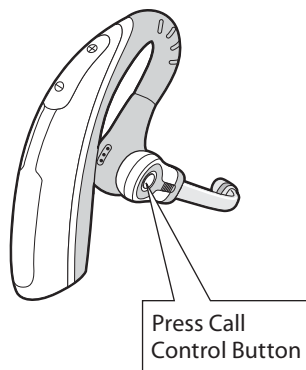

For your safety, do not use headset at high volumes for extended periods of time. Doing so can cause hearing loss. Always listen at moderate levels. For more information on headsets and hearing visit: www.plantronics.com/healthandsafety

B. Set the Configuration Dial

Once you have dialed the Automated Sound Test, follow the prompts to find the setting that gives you the clearest sound. Use a coin or large paperclip to turn the Configuration Dial.

Configuration Dial

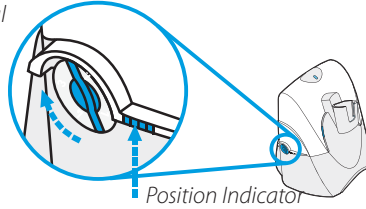

Multiple settings might work with your phone; however, only one is the optimal position.

C. Set Listening Volume

While listening to the Automated Sound Test, adjust the listening volume by using the Listening Volume Switch on the back of the Base.

Listening Volume Switch

Position 1 = Loudest
Position 4 = Softest

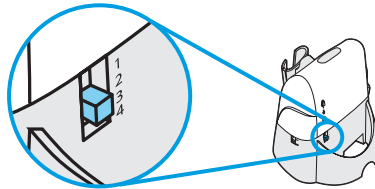

D. Set Speaking Volume

While listening to the Automated Sound Test, set the Speaking Volume Switch to the best setting for the listener (a paper clip or pen tip can help). Too high a setting can produce an uncomfortable echo for you and distorted sound for your listeners. You will be able to make minor adjustments to speaking volume while on a call using the Speaking Volume Control on the back of the base.

Speaking Volume Switch

Position A = Softest
Position D = Loudest

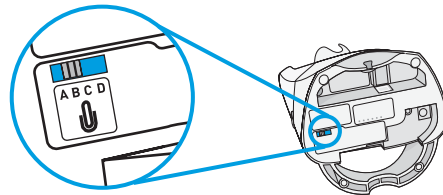

Congratulations!

You have successfully setup your CS70 Series Headset System.

To begin using your Headset System or help with service, support, or warranty information, please continue with the next several pages.

USING YOUR CS70 HEADSET SYSTEM

Powering up the Headset

If the headset battery is charged and the base is connected to power, the headset is automatically on. The CS70 does not have an *ON/OFF* button

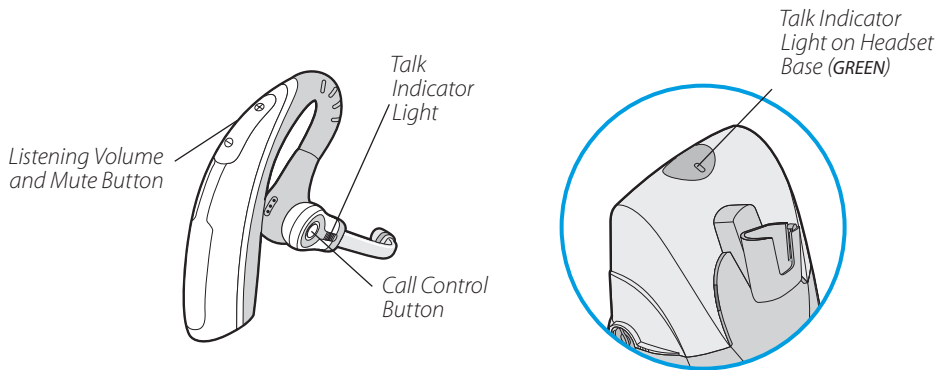

To Place, Answer, or End Calls

Desk phone Configuration	ALL phones with Handset Lifter	Phones WITHOUT Headset button and NO handset lifter	Phones WITH Headset button and NO handset lifter
To place a call	1. Press Call Control Button 2. Dial number	1. Press Call Control Button 2. Remove handset from cradle 3. Dial number	1. Press Call Control Button 2. Press Headset button on phone 3. Dial number
To answer a call	1. Press Call Control Button	1. Press Call Control Button 2. Remove handset from cradle	1. Press Call Control Button 2. Press Headset button on phone
To end a call	1. Press Call Control Button	1. Press Call Control Button 2. Press Call Control Button	1. Press Call Control Button 2. Press Headset button on phone

To Mute a Call

Press the Listening Volume Down [-] button for 3 seconds (long press). You will hear three rapid tones. These tones will be repeated every 30 seconds while mute is engaged. The *GREEN* Talk Indicator Light on the base will flash.

TO UNMUTE, long press the Listening Volume Down [-] button again for 3 seconds. You will hear three rapid tones and the Talk Indicator Light on the base will return to solid *GREEN*.

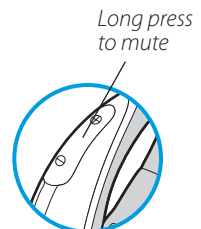

To Fine Tune Listening Volume

Press [+] to increase. You will hear ascending tones and two tones at the limit.

Press [-] to decrease. You will hear descending tones and two tones at the limit.

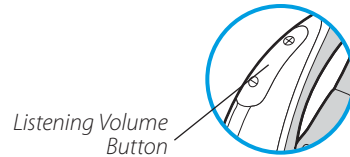

To Fine Tune Speaking Volume

While on a call, you can adjust your speaking volume by using the Speaking Volume Minor Adjustment Control on the back of the base. Listening volume can be adjusted on the headset.

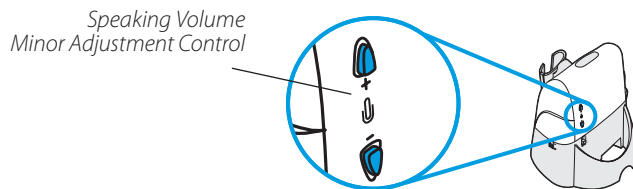

To set the IntelliStand Feature

The CS70 IntelliStand™ feature allows you to choose how to activate your headset when answering or making a call. Consider how you'll use your headset to determine the best setting for you.

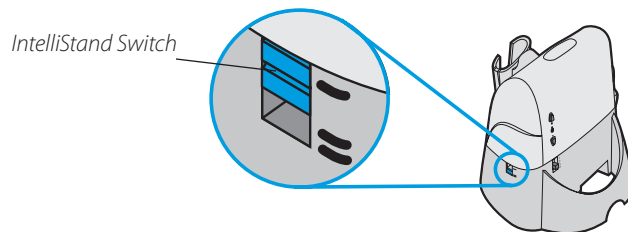

In the *UP* position, answer, make or end a call by pressing the Call Control Button on your headset. Choose the *UP* position if you plan to wear your headset most of the time.

In the *DOWN* position, calls are initiated, or answered by taking the headset out of the stand. A short delay gives you time to put the headset on. Choose the down position if you think you'll wear your headset *ONLY* while on calls. In the *DOWN* position you can still answer, end or make a call by pressing the Call Control Button.

CS70 LIGHTS AND TONES

Indicator Lights

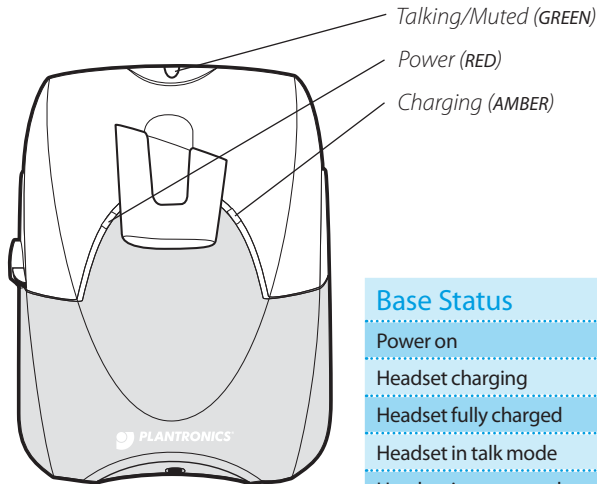

Base Status	Base Light
Power on	Solid red
Headset charging	Flashing amber
Headset fully charged	Solid amber
Headset in talk mode	Solid green
Headset in mute mode	Flashing green
Headset Status	Headset Light
Headset in talk mode	Flashing amber

Tones

Out of Range Warning:

If you walk out of range of your base, your headset will issue audible tones at its operating limit.

If you are on a call, you will hear two tones when reaching edge of range, and again when back in range. If you stray out of range, active calls will be suspended. Calls will be re-established on walking back into range. If you remain out of range for more than 10 minutes the system will drop the call.

Low Battery Warning:

When battery is low, a single tone repeats every ten seconds. You should recharge the headset immediately.

Mute Warning:

When Mute is first activated, three rapid high tones will sound. These tones will repeat every 30 seconds while Mute is active.

When Mute is deactivated you will hear three rapid low tones.

TROUBLESHOOTING AND COMMON QUESTIONS

I can't hear a dial tone at the headset

- Make sure your headset is charged.
- Press the Call Control Button on your headset.
- Make sure the lifter is lifting the handset high enough to operate the hookswitch; set to a higher setting if necessary.
- Adjust the Configuration Dial on the left side of the base. Align the "1" on the dial with the ridges to the right side of the dial. If there is no dial tone for setting "1" try the other dial settings. Adjust the Listen Volume Button on the headset. If the volume is still too low, select another setting on the Listening Volume Switch on the headset base.

I hear static

- Make sure there is at least 12" between your CS70 base and your computer, and 6" between your base and your telephone. If adjusting the distance doesn't help, your base settings may need adjusting. Call the Automated Sound Test at 866-210-2157.
- Your system may need to be reset. See the System Reset topic in the CS70 User Guide (available online at www.plantronics.com/cs70).

The sound is distorted or I hear an echo in the headset.

- Reduce speaking volume by changing the Speaking Volume Major Adjustment Switch.
- Point microphone towards your chin.
- Listening volume may be too high on phone. If your

phone has a handset volume control, lower this until the distortion disappears.

- If the distortion is still present, lower the volume using the Listen Volume Button on the headset. If the distortion persists, select another Listening Volume Switch setting on the headset base.
- Make sure there is 12" distance between your CS70 base and your computer, and 6" between your base and your telephone.

People I talk to can hear a buzz in the background.

- Move the base further away from your phone.
- Power adapter is plugged into a power strip. Plug the power adapter into the wall directly.

Talk time performance is significantly degraded even after a full recharge.

- Battery is wearing out. Call Plantronics at (800) 544-4660 Ext. 5538 for factory service information.

The Handset lifter is installed but does not lift the handset.

- Be sure the handset lifter power cord is firmly pushed into the handset lifter jack on the base.

My handset lifter operates every time I remove or replace my headset in the base.

- IntelliStand is enabled. To disable this feature, move the IntelliStand switch to the UP position.

Additional Information and Support

CS70 Interactive Quick Start Guide

(Available at www.plantronics.com/CS70)

Positioning the Base
System Reset
Battery Replacement
Maintenance
Troubleshooting

Product information

(Available at www.plantronics.com/CS70)

CS70 Online Product Resource Center

CS70 Accessories (see www.plantronics.com)

HL10 Automatic Handset Lifter
Online Indicator Light

Telephone Support

Telephone Tech Support at: **800-544-4660 Ext. 5538**

(Sunday 3:00 PM to Friday 5:00 PM, PST)

Plantronics Automated Sound Test Machine at:

866-210-2157

Online Technical Support

www.plantronics.com/support

Knowledge Base FAQs
Live Chat with a Support Technician
Email Support
Product Compatibility Guide
Product Manuals
(including all available language versions)
Service
Product Registration



This Plantronics headset delivers superior durability and reliability backed by a one-year warranty. Questions? 800-544-4660 www.plantronics.com

Plantronics Limited Warranty

- This warranty covers defects in materials and workmanship of products manufactured, sold or certified by Plantronics which were purchased and used in the United States.
- This warranty lasts for one year from the date of purchase of the products.
- This warranty extends to you only if you are the end user with the original purchase receipt.
- We will, at our option, repair or replace the products that do not conform to the warranty. We may use functionally equivalent reconditioned/refurbished/remanufactured/pre-owned or new products or parts.
- To obtain service in the U.S., contact Plantronics at (800) 544-4660 Ext. 5538.
- THIS IS PLANTRONICS COMPLETE WARRANTY FOR THE PRODUCTS.
- This warranty gives you specific legal rights, and you may also have other rights that vary from state to state. Please contact your dealer or our service center for the full details of our limited warranty, including items not covered by this limited warranty.

Maintenance

- Always unplug the Headset Base from the telephone and the Base Power Adapter from the power source before cleaning.
- Clean the equipment with a damp (not wet) cloth.
- Do not use solvents or other cleaning agents.

Battery replacement

The custom battery supplied in your headset should last 2–3 years. When talk time decreases significantly, the battery may need replacing. Please call Plantronics at (800) 544-4660 Ext. 5538 for information on sending the headset back to Plantronics for installation of a new battery.

Still having problems?

Given the hundreds of different types of phones, it's possible a trick or two may be needed to make the CS70 System work with your desk phone. For further help:

- For the product knowledge base and instant live chat with Technical Support: **www.plantronics/support**
- For the Plantronics Technical Support Center (open from Sunday 3:00 PM to Friday 5:00 PM PST, except major U.S. holidays): **800-544-4660 Ext. 5538**

© 2007 Plantronics, Inc. All rights reserved. Plantronics, the logo design, CS70, IntelliStand, and Sound Innovation are trademarks or registered trademarks of Plantronics, Inc. All other trademarks are the property of their respective owners.

Patents U.S. 5,210,791; 6,735,453; 6,923,688; 7,075,270; D469,756; D535,980; Australia 147229; 303053; China ZL200530008542.5; EM 293964-0003; 543798-0001; 543798-0002; France 651,857-651,865; Germany 40108524.4; GB Regd.Des.No. 2104923 and Patents Pending

Printed in USA.

76529-01 (02.07)



Plantronics, Inc.
345 Encinal Street
Santa Cruz, CA 95060 USA
www.plantronics.com